



Instruction Manual

Heated Lid & Heated Plate for Multi-Well Plates (Nikon Ti-S-E or Ti-S-ER)



Table of contents

Safety Considerations	4
Specifications	6
Compatibility.....	7
Preface	8
Notices	8
Limited Warranty.....	9
Installation Requirements.....	10
Installation and Connecting Cables	11
Maintenance and Operation	12
Waste Treatment	13
1 Working Principle	14
2 Overview.....	15
2.1 System Overview	15
2.2 Components	16
2.3 Heated Lid	17
2.4 Heated Plate with glass bottom	17
2.5 Sterilization and Cleaning.....	18
2.6 Setting into Operation.....	18
3 Temperature Calibration.....	19
3.1 Calibration Routine	19
3.2 Influence of Surrounding Temperature and Airflow.....	20
4 Troubleshooting	21
4.1 Focus Not Stable	21
4.2 Evaporation Too High.....	21
4.2.1 Silicone Oil Procedure (ibidi's Anti-Evaporation Oil).....	21
5 WEEE/RoHS Compliance Statement	22

Safety Considerations

To ensure operation safety, the ibidi heating devices must be operated correctly and maintained according to a regular schedule. Carefully read to fully understand all safety precautions in this manual before operating the instrument. Please take a moment to understand what the signal words **WARNING!**, **CAUTION** and **NOTE** mean in this manual.

Safety symbols

WARNING!

A **WARNING!** indicates a potentially hazardous situation which, if not avoided, could result in serious injury or even death.

CAUTION

A **CAUTION** indicates a potentially hazardous situation which, if not avoided, may result in minor or moderate injury. It may also be used alert against damaging the equipment or the instrument.

Do not proceed beyond a **WARNING!** or **CAUTION** notice until you understand the hazardous conditions and have taken the appropriate steps.

NOTE

A **NOTE** provides additional information to help the operator achieve optimal instrument and assay performance.



READ MANUAL label. This label indicates that you have to read the manual before using the instrument.



This symbol indicates important notes.

Nomenclature



**TEMPERATURE
CONTROLLER**



HEATED LID



HEATED PLATE

WARNING! Only operate the ibidi heating devices with an ibidi Temperature Controller.

WARNING! Only operate the ibidi heating devices with the supplied cables and plugs. Using other cables, etc. poses a risk of electrical shock and fire.

WARNING! Do not operate the ibidi heating devices with substances, or under conditions that can cause a risk of explosion, implosion or release of gases. Only operate the heating devices with aqueous solutions.

CAUTION Some accessible parts of the plate and lid can reach temperatures up to 55°C. Avoid touching the temperature-controlled parts of the system when you have set the temperature controller to high temperatures.

CAUTION The glass bottom of the heated plate may break due to a mechanical impact. Avoid contact between the glass bottom and the objective lens. Changing objective lenses automatically may lead to a collision between the objective lens and the glass bottom. Never change to an objective lens with a working distance smaller than 1 mm.

CAUTION If the glass plate of the heated lid or plate breaks due to a mechanical impact, the shards can lead to injuries if handled.

CAUTION Be aware that when the system is switched on, 10 V AC voltage is applied to the underside of the glass plates. Do not touch the underside or put it in contact with anything conductive. This could cause a short circuit that may destroy the temperature controller and/or the heating devices.

CAUTION Do only use the heating devices in dry rooms and do not use the heating devices in the cold room.

CAUTION Turn off the power switch in the back of the chassis of the temperature controller, when the heating devices are not in use.

CAUTION Use the devices only for cell experiments with aqueous solutions.

CAUTION Do not use the devices with hazardous substances or substances/materials that pose a risk of infections.

Specifications

Supply Voltage	
Heated Plate	12 V / 50 Hz - 12 V / 60 Hz
Heated Plate – Glass Bottom	10 V / 50 Hz - 10 V / 60 Hz
Heated Lid	10 V / 50 Hz - 10 V / 60 Hz

Surrounding Conditions	
Storage Temperature	-5 – 50°C
Operating Temperature	15 - 40°C (Indoor use only)
Humidity	80 % relative humidity up to 31°C, 30 % relative humidity up to 40°C
Operating altitude	Max. 2000 m

Temperature Control Range	Ambient temperature to +55°C
Temperature Deviation (between wells of 96 w. plate)	Max +/- 0.5°C

Net Dimensions (h×w×d)	
Heated Plate	8 x 236 x 155 mm ³
Heated Lid	25 x 160 x 108 mm ³
Heated Plate with Lid	30 x 236 x 155 mm ³

Weight	
Heated Plate	530 g
Heated Lid	210 g

Recommended Temperatures before Calibration	
(see 3.1 Calibration Routine)	
Heated Lid (Channel 1)	42°C
Heated Plate (Channel 2)	37°C
Heated Glass Bottom (Channel 3)	37°C

Restrictions for objective lenses	Working distance > 1 mm
Restrictions for condensers	Working distance > 30 mm

Compatibility

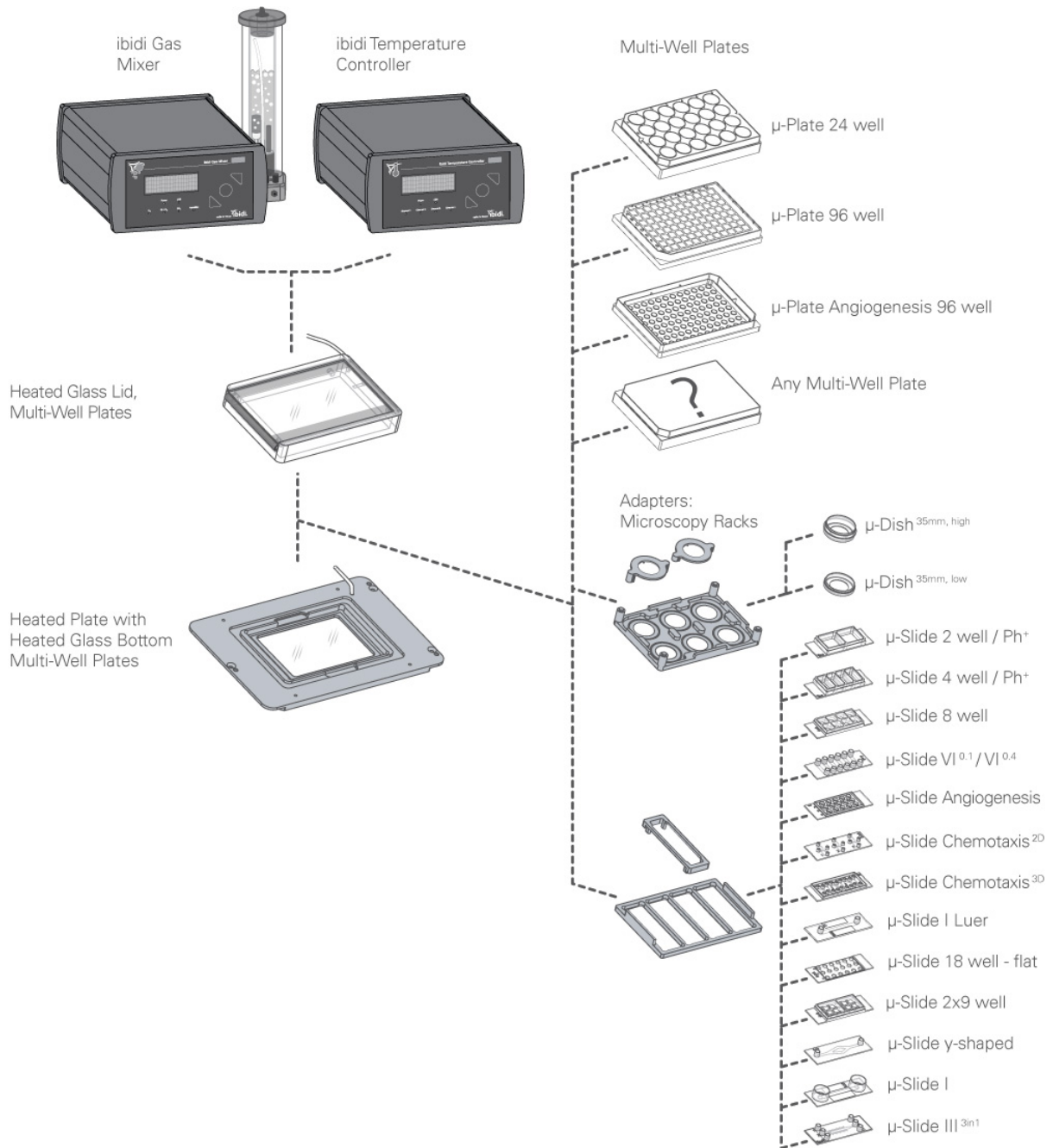

Preface

This manual is your guide to using the ibidi Heated Lid & Heated Plate for cell culture experiments on an optical microscope. It instructs first-time users how to use the instrument, and serves as a reference for experienced users.

Before using the ibidi heating devices, please read this instruction manual carefully, and make sure that the contents are fully understood. This manual should be easily accessible to the operator at all times during instrument operation. When not using the devices, keep this manual in a safe place. If this manual gets lost, order a replacement from ibidi GmbH.

Notices

1. ibidi shall not be held liable, either directly or indirectly, for any consequential damage incurred as a result of product use.
2. Prohibitions on the use of ibidi software
 - Copying software other than for backup
 - Transfer or licensing of the right to use software to a third party
 - Disclosure of confidential information regarding software
 - Modification of software
 - Use of software on multiple workstations, network terminals, or by other methods
3. The contents of this manual are subject to change without notice for product improvement.
4. This manual is considered complete and accurate at the time of publication.
5. This manual does not guarantee the validity of any patent rights or other rights.
6. If an ibidi software program has failed causing an error or improper operation, it may be due to a conflict from another program operating on the notebook (PC). In this case, take corrective action by uninstalling the conflicting product(s).
7. ibidi is a registered trademark of ibidi GmbH in Germany and other countries.

Limited Warranty

Products sold by ibidi, unless otherwise specified, are under warranty for a period of one year from the date of shipment, and should be delivered free of defects in materials and workmanship. If any defects in the product are found during this warranty period, ibidi will repair or replace the defective part(s) or product free of charge.

THIS WARRANTY DOES NOT APPLY TO DEFECTS RESULTING FROM THE FOLLOWING:

- 1 IMPROPER OR INADEQUATE INSTALLATION.
- 2 IMPROPER OR INADEQUATE OPERATION, MAINTENANCE, ADJUSTMENT, OR CALIBRATION.
- 3 UNAUTHORIZED MODIFICATION OR MISUSE.
- 4 USE OF UNAUTHORIZED CELL CULTURE WARE.
- 5 USE OF CONSUMABLES, DISPOSABLES, AND PARTS NOT SUPPLIED BY AN AUTHORIZED IBIDI DISTRIBUTOR.
- 6 CORROSION DUE TO THE USE OF IMPROPER SOLVENTS, SAMPLES, OR DUE TO SURROUNDING GASES.
- 7 ACCIDENTS BEYOND IBIDI'S CONTROL, INCLUDING NATURAL DISASTERS.

This warranty does not cover consumables like cell culture dishes, reagents, and the like.

The warranty for all parts supplied and repairs provided under this warranty expires on the warranty expiration date of the original product. For inquiries concerning repair service, contact ibidi after confirming the model name and serial number of your ibidi system.

Installation Requirements

To ensure operation safety, observe the following conditions:

1. Only operate the ibidi heating devices with an ibidi Temperature Controller and with the supplied power cable.
2. Ensure that the power plug of the power supply is well accessible. The ibidi heating devices must be installed in a way that they do not hinder the access to the external power supply and its power plug.
3. Operate the heating devices in a temperature range of 15 – 40°C.
4. Operate the heating devices in a humidity range of 0 – 80% RH up to 31°C and 30% RH up to 40 °C.
5. Operate the heating devices in an atmospheric pressure range of 800 – 1060 hPa.
6. Do not operate the heating devices under conditions that pose a risk of explosion, implosion, or the risk of any gas release.
7. Avoid strong magnetic fields and sources of high frequency. The heating devices may not function properly when operating near a strong magnetic field or high frequency source.
8. Avoid vibrations from vacuum pumps, centrifuges, electric motors, processing equipment and machine tools.
9. Avoid dust and corrosive gas. Do not install the heating devices where they may be exposed to dust, especially in locations exposed to outside air or ventilation outlets.
10. Do not install the heating devices in a location where they may be exposed to direct sunlight.
11. Install the heating devices in a horizontal and stable position. This includes a table, bench, or desk upon which the devices are installed.
12. Ensure that no air conditioner blows air directly onto the heating devices. This may prevent stable conditions.
13. Install the heating devices in a location that allows easy access for maintenance.

NOTE: The above conditions do not guarantee optimal performance of these heating devices.

Installation and Connecting Cables

Connecting the ibidi heating devices to the ibidi Temperature Controller

Confirm that the power switch of the Temperature Controller is off (power switch is at the right, rear side of the Temperature Controller).

Connect the heated lid and the heated plate to the connectors at the rear of the Temperature Controller. Connect each device to the connector labeled with the number of the channel you want to use. (e.g. channel "1" for the heated lid, "2" for the heated plate and "3" for the glass bottom of the heated plate)

Mount the heating system into the Nikon Ti-S-E or Ti-S-ER motorized stage. Secure the system by using the three screws delivered with the Nikon motorized stage.

To remove the heating system from the motorized stage, remove the three screws and use the cable to pull out the system.

WARNING! Only operate the ibidi heating system with the supplied cables and plugs, because not doing so may put you at risk of electrical shock and fire.

CAUTION Ensure that the power plug of the external power supply is well accessible. The heating system must be installed in a way that it does not hinder the access to its power plug.

Connect the temperature controller to a Notebook by using the supplied network cable. (Only necessary when using a PC to control the Heating System.)

Switch on the temperature controller and the Notebook.

Maintenance and Operation

Pay close attention to the heating devices operating environment and always keep it clean so that the heating devices can be used in a stabilized condition over a long period of time.

Operating the ibidi Heating Devices

Use the devices only in the intended application described in this manual.

CAUTION Unintended use which is not in compliance with this manual, can lead to a failure of the devices' protective systems. This failure may cause personal injury or damage.

Cleaning the ibidi Heating Devices

Switch off the Temperature Controller and disconnect the heating devices from the controller. To clean the devices use only a dry cloth or a cloth dampened with water (ultrapure) or common lab disinfection solutions that are based on quaternary ammonium compounds (e.g., Barrycidal 36 or Pharmacidal).

CAUTION The use of ethanol or other types of organic solvents to clean the devices may remove the devices' paint.

Transporting the ibidi Heating Devices

First, switch off the Temperature Controller and then disconnect the heating devices from the controller. Carry the devices carefully and avoid mechanical shocks.

Repairing the ibidi Heating Devices

Do not try to repair the devices by yourself. Contact the ibidi service to repair any damaged components.

CAUTION The manual disassembling of the devices is not allowed. Manual disassembling poses a risk of personal injury or damage to the devices. Contact ibidi service personnel if there is need to disassemble the devices.

Waste Treatment

Waste treatment is your own responsibility. You must dispose of the waste using a company that specializes in waste recovery. Do not dispose of the ibidi heating devices in a trash bin or at a public waste disposable site. For detailed information, please contact the ibidi service.

1 Working Principle

The stage top incubator for multi-well plates consists of a heated plate with a heated glass bottom, and also a heated lid that is designed to keep cells at 37°C in multi-well plates. The heated lid prevents condensation effects inside the entire incubation system. Humidity, CO₂ enriched, and/or O₂ reduced/enriched air can be flushed in, which makes the heated chamber a fully controlled incubator—right on the microscope. This enables the user to perform live cell imaging.

The glass top of the lid, the glass bottom of the plate and the plate itself are actively heat-controlled. The heated plate has the outer dimensions of the exchangeable centerpiece of the Nikon Ti-S-ER motorized stage (236 mm x 155 mm).

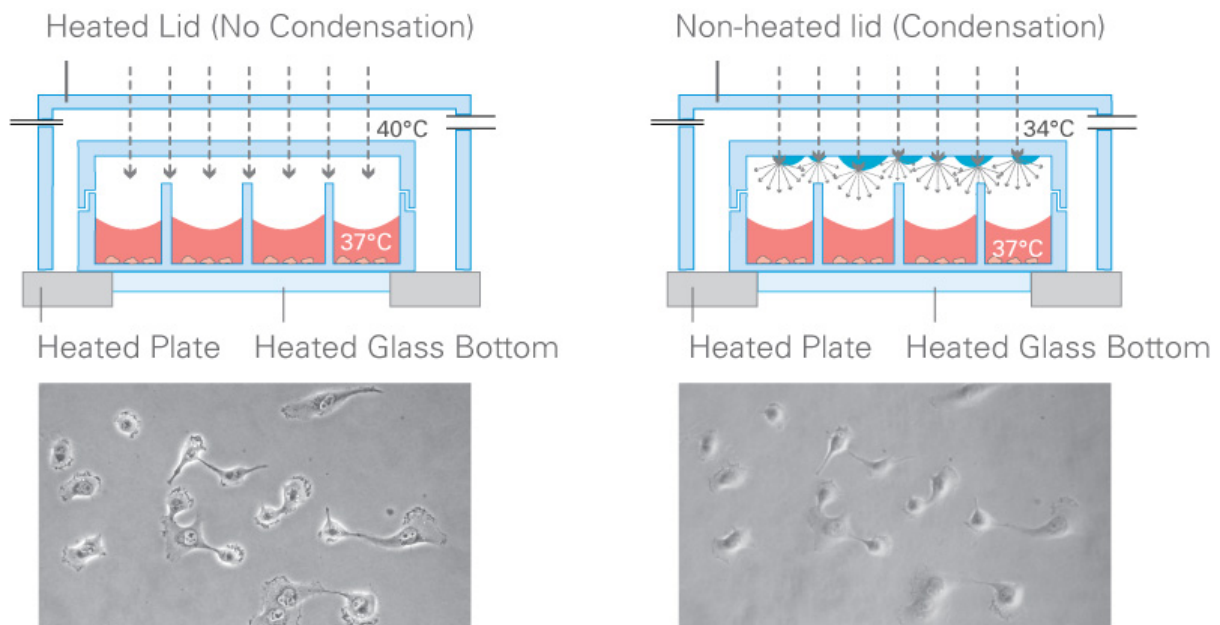
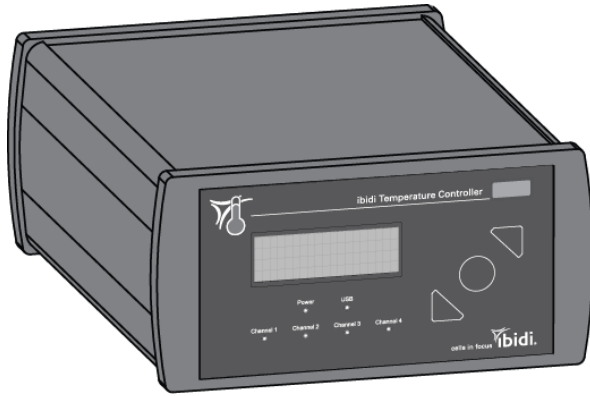

Figure 1: Schematic Drawing of the ibidi Heating devices

2 Overview

2.1 System Overview



Temperature
Controller

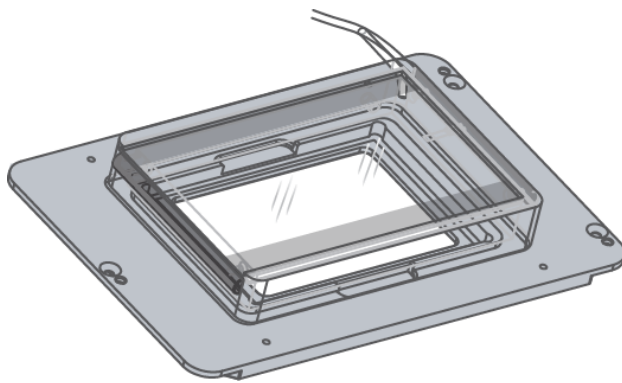



Heating
Devices



Optional:
Computer

2.2 Components

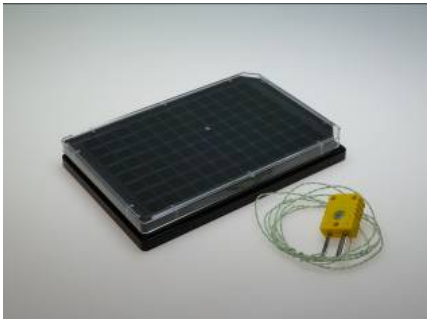
<p>ibidi Heated Glass Lid for Multi-Well Plates (Nikon Ti-S-E / Ti-S-ER)</p>	
<p>ibidi Heated Plate with heated glass bottom for Multi-Well Plates (Nikon Ti-S-E / Ti-S-ER)</p>	
<p>Calibration Set (1 temperature sensor + 1 perforated μ-Plate 96well)</p>	

2.3 Heated Lid

The heated lid (160 mm x 108 mm) provides excellent optical quality, and also allows for the use of all standard microscopy techniques, including differential interference contrast (DIC). The upper glass part is electrically heat controlled. The heated lid fits accurately onto the heated plate.



For gas incubation, the lid is equipped with inlets for (a) the gas flow and (b) the humidity sensor.

Due to the height of the lid, we recommend using condensers with a working distance of > 30 mm.

2.4 Heated Plate with glass bottom

The heated plate provides the base for the heating devices. Its format (236 mm x 155 mm) fits exactly the exchangeable centerpiece of the Nikon Ti-S-ER motorized stage. The glass bottom and the plate itself are both actively heated. The heated plate is the counterpart to the heated lid.



2.5 Sterilization and Cleaning

The Heated Plate and the Heated Lid do not have to be sterile, because the incubation chamber has no direct contact with the cells and the cell media. If sterilization is necessary for some reason, we recommend using isopropanol (70%) or common lab disinfection solutions based on quaternary ammonium compounds. (e.g. Barrycidal 36, Pharmacidal)

All Heating Devices can be cleaned. We recommend using ultrapure water for cleaning. Stains on the Heated Lid or the glass bottom of the Heated Plate can be removed using isopropanol (70%) or lens/eyeglass cleaning wipes.

Make sure not to apply too much pressure when cleaning the glass bottom of the plate to avoid damaging the glass.

2.6 Setting into Operation

Here is the procedure to start the operation of the heating devices in combination with the ibidi Temperature Controller.

For the first power up, we recommend disconnecting the heating devices. By doing this, you ensure that you do not start heating with the wrong temperature settings. It is now possible to set the temperatures for the individual channels. Afterwards, you can reconnect the heating devices.

Since the controller is preconfigured, we recommend connecting the heated lid to Channel 1 the heated plate to Channel 2 and the glass bottom of the heated plate to Channel 3. For subsequent power ups, you will not need to disconnect the heating devices.



Please let the temperature of the system equilibrate for a minimum of 30 minutes before you start your experiments.



Be aware that when the system is switched on, 10V AC voltage is applied to the underside of the glass plate. Do not touch the underside or contact it with anything conductive. This could cause a short circuit that may destroy the controller and/or the lid.



3 Temperature Calibration

The temperature at the position of the cells must be calibrated from time to time, due to the following conditions: room temperature, air conditioning, heat loss via microscope, chamber type or objective lens, and humidification. A calibration is recommended before beginning the first experiment. The heat calibration should be done for each chamber type, in order to control temperatures with an absolute accuracy of less than 1°C.

For calibration, the ibidi Temperature Controller has a plug, located on the rear panel, for an external temperature sensor. Before shipment, all controllers are run through an in-house calibration to ensure their accuracy. This calibration only refers to the actively heated devices, such as the plate and the lid. In most cases, the cell temperature will lie somewhat below the temperature of the heated plate. To compensate for this effect, the heated plate can be calibrated to the cell temperature that is sensed by the external temperature sensor, which can be placed at the position of the cells.



The displayed temperatures are valid for the heating devices only. The temperature near the cells might be different (lower in most cases)!

3.1 Calibration Routine

The recommended calibration routine is fairly simple. Follow these eight steps for the initial temperature calibration:

- 1) Plug the external temperature sensor into the rear panel of the Temperature Controller.
- 2) Fill the multi-well plate you want to use with medium and place the sensor as close as possible to the future position of the cells. Use the prepared calibration set, which consists of a μ -Plate 96 well with a perforated lid, as shown in Figure 2 on page 20.
- 3) Set all parameters to create conditions identical to those of the actual experiments, such as room temperature, air conditioning, airflow, illumination, microscope settings, etc.
- 4) Set the temperature of glass bottom and heated plate to the desired cell temperature and set the temperature of the lid several degrees higher (recommended values: glass 37°, plate 37 °C, lid 42 °C). You can do this directly with the control buttons on the controller, or with the TempControl software.
- 5) Let the system equilibrate for 30 minutes.

- 6) In most cases the temperature shown by the external sensor will not match the value of the plate. In that case increase or decrease the temperature of the glass bottom of the plate (recommended in 0.5 °C steps for small deviations). Let the system equilibrate for another 5 minutes.

Repeat this step until you reach the desired temperature at the external sensor.

- 7) Note the adjusted set values in your documentation for future experiments.
- 8) Check the temperature of the system from time to time.



It is recommended to perform this routine once every year.

It is recommended to perform this routine when a change of temperature conditions has occurred.

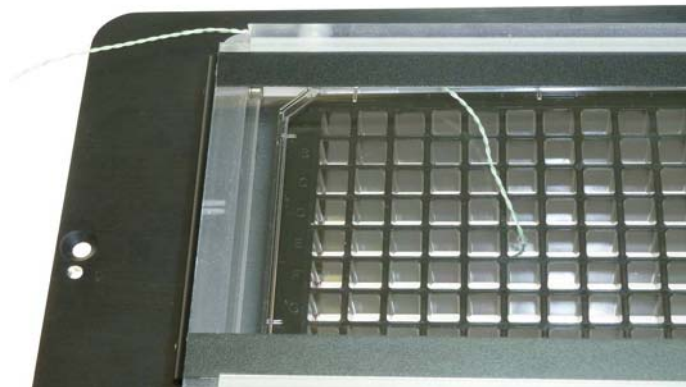

Figure 2: Sensor Placement for Temperature Calibration

3.2 Influence of Surrounding Temperature and Airflow

The surrounding, ambient temperature affects the temperature inside the microscopy chambers. Devices, such as computers and camera controllers, can significantly heat up small rooms. In this case, we recommend equilibrating the room temperature to the typical experimental conditions at least 2-3 hours before calibrating.

Keep in mind that the temperature sensor can also measure room temperatures.

The airflow can enhance the effect of temperature changes in the vicinity of the incubation chamber. In a case where the airflow (e.g., air conditioning, etc.) cannot be stopped, we recommend protecting the microscope as much as possible from any strong airflow. Please contact us for support.

4 Troubleshooting

4.1 Focus Not Stable

Focus drift is a disturbing effect, especially during time-lapse experiments. Focus stability is mainly influenced by mechanical changes and temperature variations. Follow these recommendations to keep your cells in focus:

- Switch on all components (heating, gas incubation, computer, other equipment) at least 60 minutes before starting the experiment.
- After you put the sample onto the microscope, wait 20 minutes before starting a time-lapse experiment to achieve temperature and immersion oil equilibration. (*)
- Keep the room temperature as stable as possible. Air conditioning should either be working continuously or switched off.
- Do not change the temperature during the experiments. Avoid door/window openings, as this could rapidly change the temperature.
- Eliminate all sources of mechanical vibrations. Use a damped table for your microscope.

(*) In case the experiment needs to be started immediately, either after placing the sample on the microscope, or after closing the lid, we recommend controlling the focus for 20 minutes. In the first minutes after starting the experiment, temperature equilibration might influence the focus/z-position of the cells.

4.2 Evaporation Too High

Depending on the incubating conditions, small volumes might evaporate quickly, especially during long-term experiments. We suggest using silicone oil (e.g. Anti-Evaporation Oil, ibidi, 50051) to decrease evaporation. If you have an actively controlled humidifying device, increase the set value of relative humidity.

4.2.1 Silicone Oil Procedure (ibidi's Anti-Evaporation Oil)

Covering the medium with sterile silicone oil prevents all evaporation effects and is compatible with cell culture. Please don't use mineral oil, as this would be harmful to the ibidi μ -Slides.

Equilibrate oil and medium inside the incubator overnight. This step helps avoid the formation of air bubbles, and pre-warms the solutions to 37°C. Afterwards, fill your plate with cells and medium. Cover the medium's surface with an appropriate amount of silicone oil. Don't drip the oil directly onto the surface, but let it run down the edges by pressing the pipette tip directly on the upper side of the reservoir.

Please contact us at info@ibidi.com for further troubleshooting help.

5 WEEE/RoHS Compliance Statement

EU Directives WEEE and RoHS

To Our Valued Customers:

ibidi GmbH is committed to being a good corporate citizen. As part of that commitment, we strive to maintain an environmentally conscious manufacturing operation. The European Union (EU) has enacted two directives, the first on product recycling (Waste Electrical and Electronic Equipment, WEEE) and the second on limiting the use of certain substances (Restriction on the use of Hazardous Substances, RoHS).

Two Categories of products covered by the WEEE Directive are currently exempt from the RoHS Directive – Category 8, medical devices (with the exception of implanted or infected products) and Category 9, monitoring and control instruments.

All of our products fall into either Category 8 or 9, and are currently exempt from the RoHS Directive. We will, however, continue to monitor the application of the RoHS Directive in relation to our products and will comply with any changes, as they apply.

Recycling is offered for our products that fall within the scope of the WEEE Directive. These specific products, available for sale after August 13, 2005, will be identified with a “wheelie bin” symbol.



When you see this symbol, do not dispose of this product with Municipal Waste. Special Collection/Disposal is required.

Please contact us for feedback or further information.

ibidi GmbH
Am Klopferspitz 19
82152 Planegg-Martinsried
Germany
www.ibidi.com
info@ibidi.de
Tel.: +49 89 520 4617 0
Fax: +49 89 520 4617 59