

The ibidi product family is comprised of a variety of μ-Slides and μ-Dishes, which have all been designed for high-end microscopic analysis of fixed or living cells. The high optical quality of the material is similar to that of glass, so you can perform all kinds of fluorescence experiments with uncompromised resolution and choice of wavelength.

The μ-Slide III ³ⁱⁿ¹ is designed for flow assays with different liquids merging into one channel. It can be connected to a pump and enables you to observe cells under switchable flow conditions. The design allows generating fluid stable concentration profiles in the main channel for e.g. chemotaxis experiments. The microfluidic system can generate spatially and temporally controlled gradients of chemotactic factors by laminar flow.

Material

ibidi μ-Slides, μ-Dishes, and μ-Plates are made of a plastic that has the highest optical quality. The bottom material exhibits extremely low birefringence and autofluorescence, similar to that of glass. Also, it is not possible to detach the bottom from the upper part. The μ-Slides, μ-Dishes, and μ-Plates are not autoclavable, since they are only temperature-stable up to 80°C/175°F. Please note that gas exchange between the medium and incubator's atmosphere occurs partially through the plastic bottom, which should not be covered.

Optical Properties ibidi Standard Bottom

Refractive index n_D (589 nm)	1.52
Abbe number	56
Thickness	No. 1.5 (180 μm)
Material	microscopy plastic

Please note! The ibidi standard bottom is compatible with certain types of immersion oil only. A list of suitable oils can be found on page 4.

μ-Slide Surfaces

Depending on the type of cells and the special application you are using, you will need μ-Slides with different surfaces. If you do not require any special adhesion molecules for your application, the best choice will be ibiTreat, a tissue culture treated surface.

We provide precoated μ-Slides with adhesion substrates like Collagen IV, Fibronectin, Poly-L-Lysin, and Poly-D-Lysin. Such adhesion substrates have been shown to stimulate the adhesion and growth of various cell lines in μ-Slides. Only high-quality substrates are used ¹.

The uncoated μ-Slide is manufactured from hydrophobic plastic. For the cultivation of most cell lines, it is indis-

¹Collagen IV: Corning #356233, Fibronectin: Corning #354008, Poly-L-Lysin: Sigma #P4832, Poly-D-Lysin: Corning #354210

pensible to treat the uncoated μ-Slide with biopolymers, which mediate cell adhesion and growth.

Geometry

The μ-Slide III ³ⁱⁿ¹ provides standard slide format according to ISO 8037/1.

Geometry of the μ-Slide III ³ⁱⁿ¹

Adapters	female Luer
Volume per reservoir	60 μl
Number of channels	3 in 1
Total channel volume	60 μl
Height of all channels	0.4 mm
Width of channels thin/thick	1/3 mm
Total growth area	1.23 cm ²
Distance of scale bars	1 mm
Bottom matches coverslip	No. 1.5

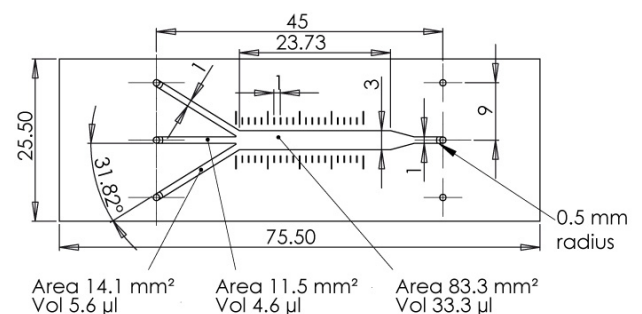

Coating your μ-Slide III ³ⁱⁿ¹

The uncoated μ-Slide must be coated to promote cell adhesion. If you want to establish a certain coating to match your needs, we recommend testing your coating procedure on both uncoated and ibiTreat μ-Slides, since we have observed that some biomolecules adhere differently to hydrophobic and hydrophilic plastic surfaces.

- Prepare your coating solution according to the manufacturer's specifications or reference.
- Apply 60 μl to adapter B (handling see below) and leave at room temperature for at least 30 minutes.
- Aspirate the solution and wash with ultra-pure water. You can add the water into one channel end and simultaneously aspirate it on the other side. Take care that all of the three channels are washed.
- Optionally let dry at room temperature. Attention, some coating proteins might degenerate when drying!

Further information about coatings are provided in [Application Note 08 Cell culture coating](#).

Filling and Handling

- Always fill the channel from adapter B as shown in the picture.
- When using a pipet make sure you place the tip directly onto the small channels inlet.
- Especially the uncoated, hydrophobic channel can be filled much easier by using a small volume syringe with a Luer tip.
- Make sure that all adapters are completely filled before Luer connectors are plugged in. Otherwise air bubbles will be trapped.

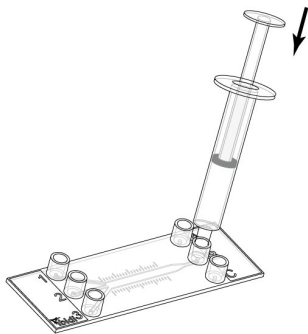

Seeding Cells

- Trypsinize and count cells as usual. Dilute the cell suspension to the desired concentration. Depending on your cell type, application of a $3-7 \times 10^5$ cells/ml results in a 20% optical confluent cell layer after attachment.
- A seeding density of $1-4 \times 10^6$ cells/ml creates a 100% optical confluent cell layer after cell attachment.

- Apply 60 μl cell suspension into adapter B of the μ-Slide. Quick dispensing helps to avoid trapped air bubbles.
- Cover reservoirs with the supplied lid. Incubate at 37°C and 5% CO₂ as usual.
- Await cell attachment in order not to flush out the cells. Afterwards fill each reservoir with 60 μl cell free medium.
- Connect the μ-Slide to the pump and conduct your perfusion experiment.

Important!

The day before seeding the cells we recommend placing the cell medium and the μ-Slide into the incubator for equilibration. This will prevent the liquid inside the channel from emerging air bubbles over the incubation time.

Exchanging Medium

Aspirate all four reservoirs and fill 60 μl of fresh medium into reservoir B, which will replace the channel volume by gravity flow. Repeat this step three times until each reservoir is filled with 60 μl.

Fluid Connections and Gradient Shapes

2 in 1

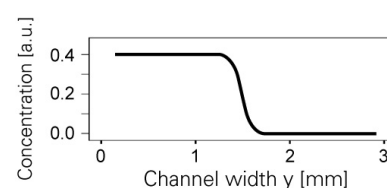
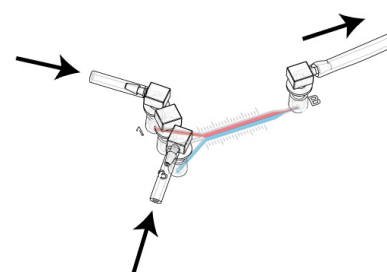

Cliff-shaped Gradients

3 in 1

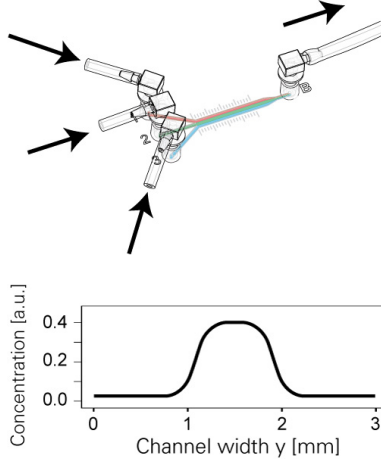

Hill-shaped Gradients

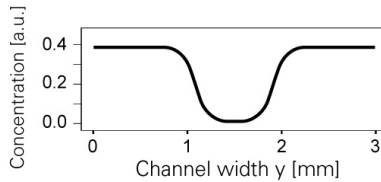

Cup-shaped Gradients

Example Experiment – Cells in Temporally Controlled Gradients

The following example experiment illustrates the idea how to setup a switchable chemical gradient in the large channel for a chemotaxis experiment.

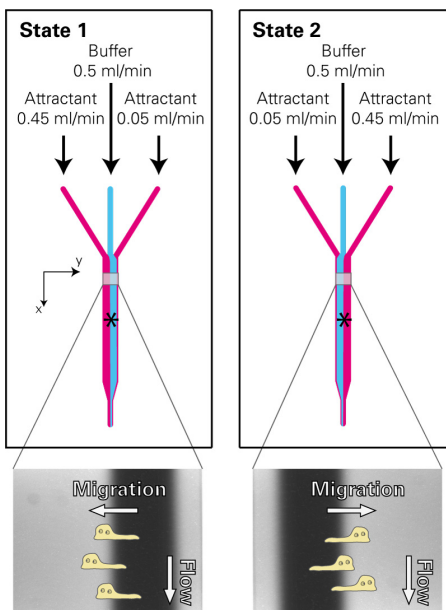

Concentration profiles can be visualized by using a fluorescent dye e.g. rhodamine. Switching time between state 1 and state 2 can range from seconds to hours, depending on the speed of the cells' response.

The concentration profile created is always sigmoid shaped and is depending on overall flow rate and position inside the channel.

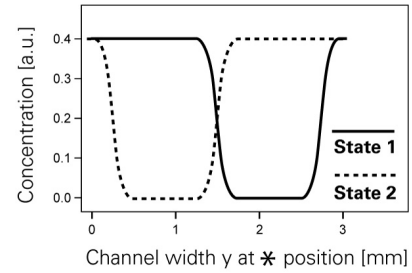

All flow rates should be adjusted in a way that the point of inflection of the sigmoid is at identical position in state 1 and state 2.

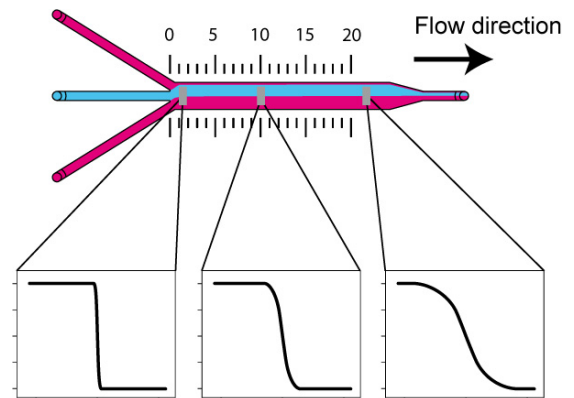

The longer liquids are in contact next to each other the smoother the sigmoid shape becomes.

Since flow is used to keep the gradients stable, there is always a shear stress applied to the cells. Please perform control experiments with the experimental flow rate to exclude polarization effects from the flow itself. Flow rates and corresponding shear stress can be found in Application Note 11 on www.ibidi.com. For example, a flow rate of 1 ml/min results in a shear stress of 2.3 dyn/cm².

Immersion Oil

When using oil immersion objectives, use only the immersion oils specified in the table. The use of a non-recommended oil could lead to the damage of the plastic material and the objective.

Company	Product	Ordering Number
ibidi	Immersion Oil	(ibidi) 50101
Zeiss	Immersol 518 F	(Zeiss) 444960
Zeiss	Immersol W 2010	(Zeiss) 444969
Leica	Immersion liquid	(Leica) 11513859

Preparation for Cell Microscopy

To analyze your cells, no special preparations are necessary. Cells can be observed live, or fixed directly in the μ-Slide on an inverted microscope. You can use any fixative of your choice. The μ-Slide material is compatible with a variety of chemicals (e.g., Acetone or Methanol). Further specifications can be found at www.ibidi.com. Due to the thin bottom of only 180 μm, high resolution microscopy is possible.

Selected References

- X. Cheng, M. Joseph, J. A. Covington, T. Dafforn, M. R. Hicks, and A. Rodger. Continuous channel flow linear dichroism. *Royal Society of Chemistry*, 2012. doi: 10.1039/C2AY25513H.
- B. Meier, A. Zielinski, C. Weber, D. Arcizet, S. Youssef, T. Franosch, J. O. Rädler, and D. Heinrich. Chemotactic cell trapping in controlled alternating gradient fields. *PNAS*, 2011. doi: 10.1073/pnas.1014853108.
- F. Moseley, J. Halamek, F. Kramer, A. Poghossian, M. Schoening, and E. Katz. Enzyme-based reversible cnot logic gate realized in a flow system. *Royal Society of Chemistry*, 2014. doi: 10.1039/C4AN00133H.

μ-Slide III³ⁱⁿ¹ Family

The μ-Slide III³ⁱⁿ¹ family is available with different surfaces. See table below for choosing your μ-Slide III³ⁱⁿ¹.

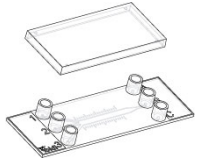

Ordering Number	Treatment or Coating	Characteristics
80316	ibiTreat, sterile	hydrophilic, tissue culture treated
80312	Collagen IV, sterile	protein coating
80313	Fibronectin, sterile*	protein coating
80314	Poly-L-Lysine, sterile	biopolymer coating
80315	Poly-D-Lysine, sterile*	biopolymer coating
80311	uncoated, sterile	hydrophobic

* available on request only

Tube Adapter Set

For the connection of the ibidi μ-Slides to any flow system suitable Tube Adapter Sets are also available. They consist of a tubing (20 cm) with inner diameter of 1.6 mm and adapters for the connection between the ibidi μ-Slide (female Luer) and the tubing of the pump in use.

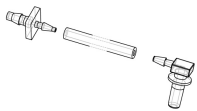

Ordering Number	Product Name	Characteristics
10831	Tube Adapter Set	12 pcs, sterile

For research use only!

Further technical specifications can be found at www.ibidi.com. For questions and suggestions please contact us by e-mail info@ibidi.de or by telephone +49 (0)89/520 4617 0. All products are developed and produced in Germany.

© ibidi GmbH, Am Klopferspitz 19, 82152 Martinsried, Germany.